



(IRM-30)



(IRM-30-xxST)



**Features**

- 2.74"x1.54"compact size
- PCB, chassis or screw terminal mounting version
- Universal input 85~305VAC
- No load power consumption<0.1W
- EMI Class B without additional components
- Wide operating temp. rage -30~70°C
- Protections: Short circuit / Overload / Over voltage
- Cooling by free air convection
- Isolation Class II
- Over voltage category III
- Pass LPS
- 3 years warranty

**Applications**

- Industrial electrical equipment
- Mechanical equipment
- Factory automation equipment
- Hand-held electronic device

**Description**

IRM-30 is a 30W miniature (69.5\*39\*24mm) AC-DC module-type power supply, ready to be soldered onto the PCB boards of various kinds of electronic instruments or industrial automation equipments. This product allows the universal input voltage range of 85~305VAC. The 94V-0 flame retardant plastic case and the fully-potted silicone enhance the heat dissipation and meet the anti-vibration demand up to 5G; moreover, it provides the fundamental resistance to dust and moisture.

With the high efficiency up to 90% and the extremely low no-load power consumption below 0.1W, IRM-30 series fulfills the worldwide regulation for the low power consumption requirement for electronics. The entire series is a Class II design (no FG pin), incorporating the built-in EMI filtering components, enabling the compliance with EN55032 Class B; the supreme EMC features keep the end electronic units from electromagnetic interference. In addition to module-type model, IRM-30 series also offers the screw terminal style model (ST).

**Model Encoding**

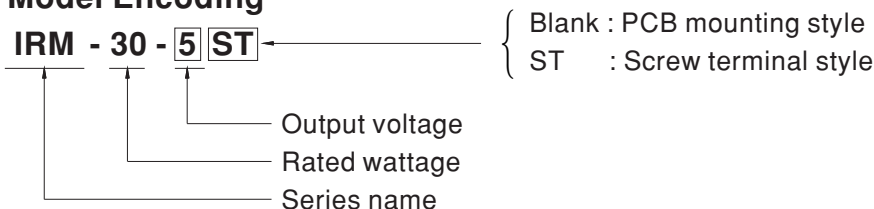

**SPECIFICATION**

MODEL		IRM-30-5 □	IRM-30-12 □	IRM-30-15 □	IRM-30-24 □	IRM-30-48 □
OUTPUT	DC VOLTAGE	5V	12V	15V	24V	48V
	RATED CURRENT	6A	2.5A	2A	1.3A	0.63A
	CURRENT RANGE	0 ~ 6A	0 ~ 2.5A	0 ~ 2A	0 ~ 1.3A	0 ~ 0.63A
	RATED POWER	30W	30W	30W	31.2W	30.2W
	RIPPLE & NOISE (max.) Note.2	120mVp-p	150mVp-p	200mVp-p	240mVp-p	300mVp-p
	VOLTAGE TOLERANCE Note.3	±2.5%	±2.5%	±2.5%	±2.5%	±2.5%
	LINE REGULATION	±0.5%	±0.5%	±0.5%	±0.5%	±0.5%
	LOAD REGULATION	±1.0%	±0.5%	±0.5%	±0.5%	±0.5%
	SETUP, RISE TIME	1000ms, 30ms/230VAC    1500ms, 30ms/115VAC at full load				
	HOLD UP TIME (Typ.)	40ms/230VAC    12ms/115VAC at full load				
INPUT	VOLTAGE RANGE	85 ~ 305VAC    120 ~ 430VDC				
	FREQUENCY RANGE	47 ~ 440Hz				
	EFFICIENCY (Typ.)	83%	88%	88%	88.5%	90%
	AC CURRENT (Typ.)	0.75A/115VAC    0.5A/230VAC    0.375A/277VAC				
	INRUSH CURRENT (Typ.)	COLD START 25A/115VAC    45A/230VAC				
	LEAKAGE CURRENT	< 0.25mA/277VAC				
PROTECTION	OVERLOAD	105% ~ 160% rated output power Protection type : Hiccup mode, recovers automatically after fault condition is removed				
	OVER VOLTAGE	5.25 ~ 6.75V	12.6 ~ 16.2V	15.75 ~ 20.25V	25.2 ~ 32.4V	50.4 ~ 64V
ENVIRONMENT	WORKING TEMP.	-30 ~ +70°C (Refer to "Derating Curve")				
	WORKING HUMIDITY	20 ~ 90% RH non-condensing				
	STORAGE TEMP., HUMIDITY	-40 ~ +85°C, 10 ~ 95% RH				
	TEMP. COEFFICIENT	±0.03%/°C (0 ~ 50°C)				
	VIBRATION	Blank:10 ~ 500Hz, 2G 10min./1cycle, period for 60min. each along X, Y, Z axes				
		ST:10 ~ 500Hz, 5G 10min./1cycle, period for 60min. each along X, Y, Z axes				
	LEAD TEMPERATURE	260±5°C, 5s (max.)				
	OVER VOLTAGE CATEGORY	III; According to EN62368-1; altitude up to 2000 meters				
	OPERATING ALTITUDE Note.4	2000 meters				
SAFETY & EMC (Note.5)	SAFETY STANDARDS	IEC62368-1, UL62368-1, TUV EN62368-1, EAC TP TC 004, BSMI CNS14336-1 approved; Design refer to EN60335-1 (By request)				
	WITHSTAND VOLTAGE	I/P-O/P:3KVAC				
	ISOLATION RESISTANCE	I/P-O/P:100M Ohms / 500VDC / 25°C / 70% RH				
	EMC EMISSION	Parameter	Standard		Test Level / Note	
		Conducted	EN55032(CISPR32), CNS13438		Class B	
		Radiated	EN55032(CISPR32), CNS13438		Class B	
		Harmonic Current (Note 5)	EN61000-3-2		Class A	
		Voltage Flicker	EN61000-3-3		-----	
	EMC IMMUNITY	EN55035, EN61000-6-2				
		Parameter	Standard		Test Level / Note	
		ESD	EN61000-4-2		Level 3, 8KV air; Level 2, 4KV contact, criteria A	
Radiated Susceptibility		EN61000-4-3		Level 3, criteria A		
EFT/Burest		EN61000-4-4		Level 3, criteria A		
Surge		EN61000-4-5		Level 4, 2KV/L-N, criteria A		
Conducted		EN61000-4-6		Level 3, criteria A		
Magnetic Field		EN61000-4-8		Level 4, criteria A		
Voltage Dips and interruptions	EN61000-4-11		>95% dip 0. 5 periods, 30% dip 25 periods, >95% interruptions 250 periods			
OTHERS	MTBF	593.3Khrs min. MIL-HDBK-217F (25°C)				
	DIMENSION	PCB mounting style : 69.5*39*24mm (L*W*H)    Screw terminal style : 91*39.5*28.5mm (L*W*H)				
	PACKING	PCB mounting style : 0.094Kg;144pcs/14.5Kg/0.97CUFT    Screw terminal style :0.113Kg;120pcs/14.6Kg/0.74CUFT				
NOTE	<ol style="list-style-type: none"> <li>All parameters NOT specially mentioned are measured at 230VAC input, rated load and 25°C of ambient temperature.</li> <li>Ripple &amp; noise are measured at 20MHz of bandwidth by using a 12" twisted pair-wire terminated with a 0.1uf &amp; 47uf parallel capacitor.</li> <li>Tolerance : includes set up tolerance, line regulation and load regulation.</li> <li>The ambient temperature derating of 3.5°C/1000m with fanless models and of 5°C/1000m with fan models for operating altitude higher than 2000m(6500ft).</li> <li>The power supply is considered as an independent unit ,but the final equipment still need to re-confirm that the whole system complies with the EMC directives. For guidance on how to perform these EMC tests, please refer to "EMI testing of component power supplies." (as available on <a href="http://www.meanwell.com">http://www.meanwell.com</a>)</li> </ol>					

■ Block Diagram

fosc : 65KHz

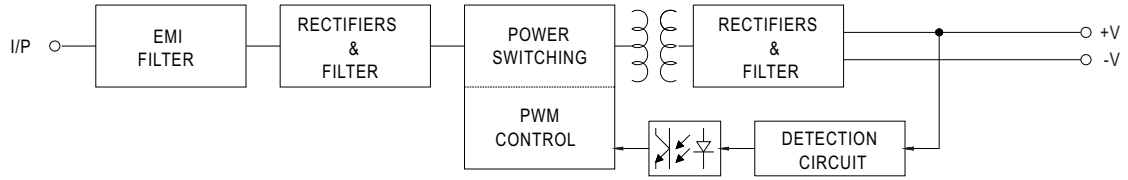

■ Derating Curve

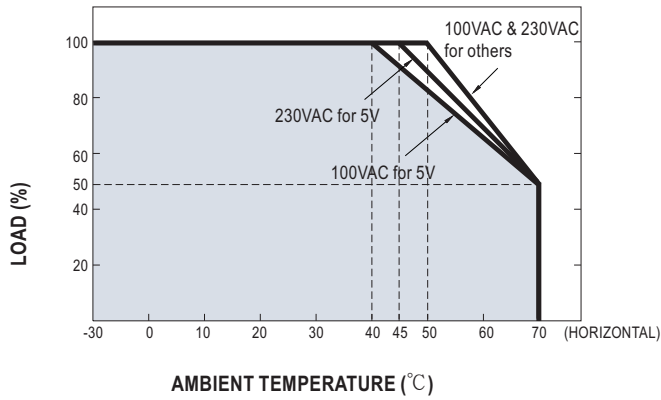

■ Output Derating VS Input Voltage

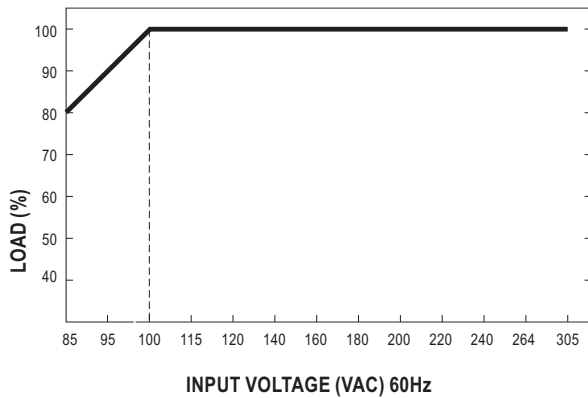

**Mechanical Specification**

Case No. Unit:mm

- PCB mounting style (IRM-30)

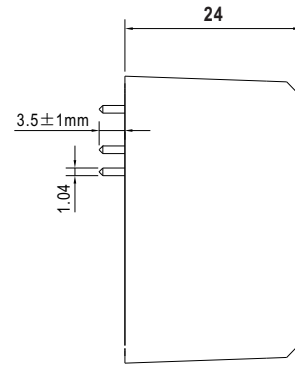
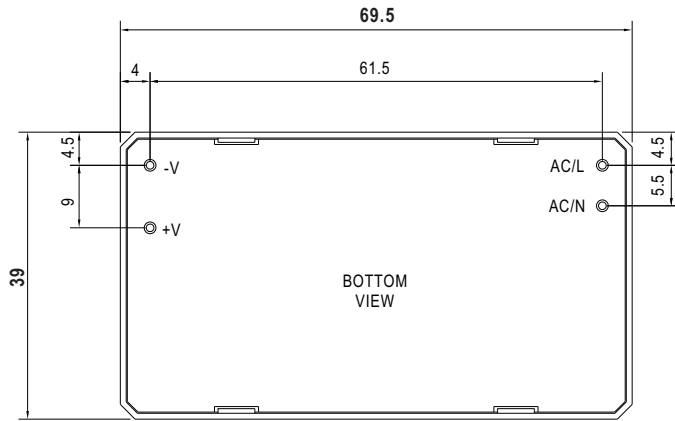

P/N diameter:1.04

- Screw terminal style (IRM-30-xxST)

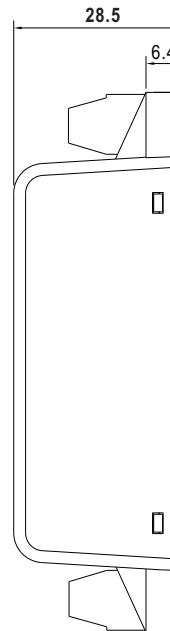
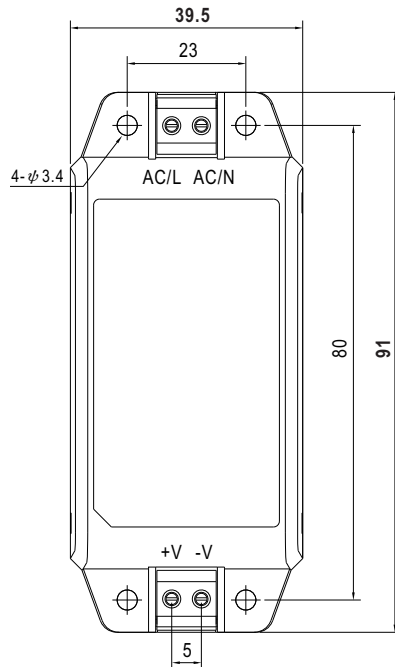

**Installation Manual**

Please refer to : <http://www.meanwell.com/manual.html>